

# 2000 GALLON SEPTIC TANK

15" DIA. STANDARD CLEANOUT PLUGS

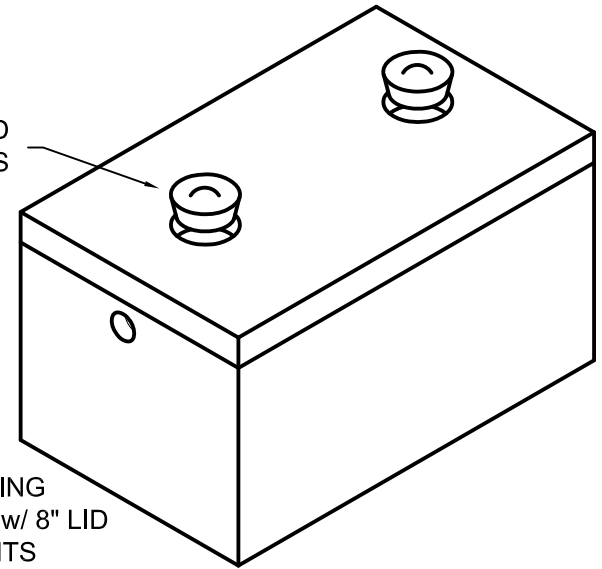

**STANDARD FEATURES:**

- 4500 PSI CONCRETE
- GRADE 60 REINFORCING
- AASHTO H-20 RATED w/ 8" LID
- 1 OR 2 COMPARTMENTS
- 4" WALLS AND FLOOR

**WEIGHT (APPROXIMATE):**

TANK	14,250 LBS
4" LID	3,900 LBS
8" LID	7,535 LBS

**NOTES:**

- ALL TANKS ARE COMPLETE WITH INLET GASKET, OUTLET BAFFLE, SEALANT BETWEEN TANK AND LID, AND CROSS-OVER BAFFLE ON DIVIDERS
- OUTLET IS 4 IN. PVC, SCH. 40. INLET FITTING WILL ACCEPT BOTH 3 IN. AND 4 IN. FITTINGS
- ALL CAPACITIES ARE **MINIMUM WORKING CAPACITIES**
- SEE SITE PREPARATION SHEET FOR IMPORTANT DEPTH LIMITATION INFORMATION



**HILL COUNTRY**  
 CONCRETE PRODUCTS, INC.

PO Box 357  
 Kyle, Texas 78640  
 512.268.9711  
 Austin Line 512.476.5838  
 Fax 512.268.0215  
 hillcountryconcrete.com

2000 GALLON SEPTIC TANK