

DATE: 05/14/2009 DRAWING NAME: HCCP_GI-SA5000

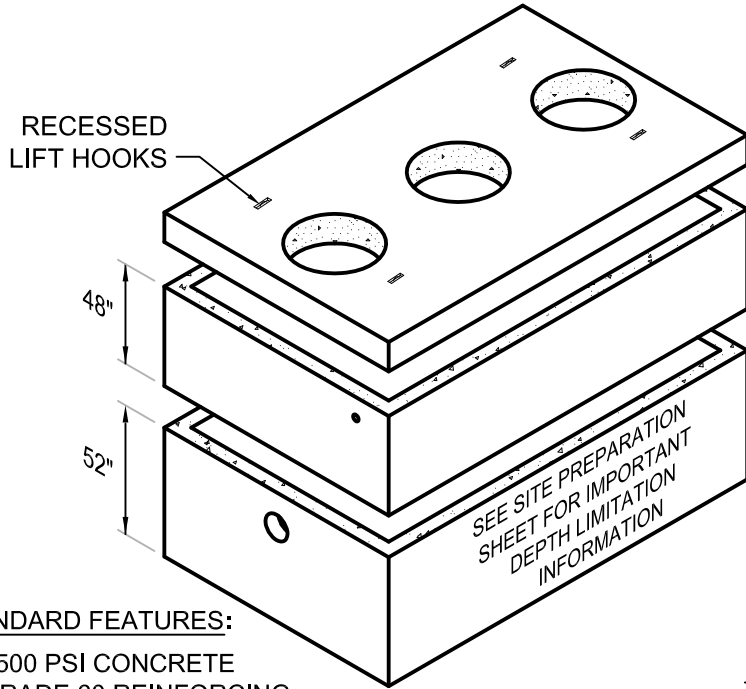

STANDARD FEATURES:

- 4500 PSI CONCRETE
- GRADE 60 REINFORCING
- 8" TRAFFIC BEARING LID
- AASHTO H-20 RATED
- 4" WALLS AND FLOOR

WEIGHT (APPROXIMATE):

TANK	19,170 LBS
48" EXTENSION	12,264 LBS
8" LID	12,650 LBS
TOTAL	43,085 LBS

NOTES:

- GROUND WATER LEVEL MUST BE 6 FT OR MORE BELOW GRADE
- ALLOW FOR MANHOLE RING AND COVER IN TOTAL HEIGHT
- STANDARD INLET/OUTLET FITTINGS ARE 6" SCH 40 PVC (4" AVAILABLE)
- **MAXIMUM BURY DEPTH TO BOTTOM OF TANK**
 AASHTO H-20 LOADING: 11 FT
 NON TRAFFIC (SOIL) LOADING: 13 FT

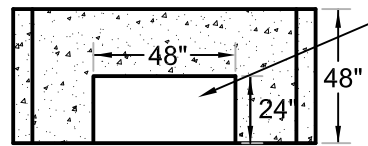
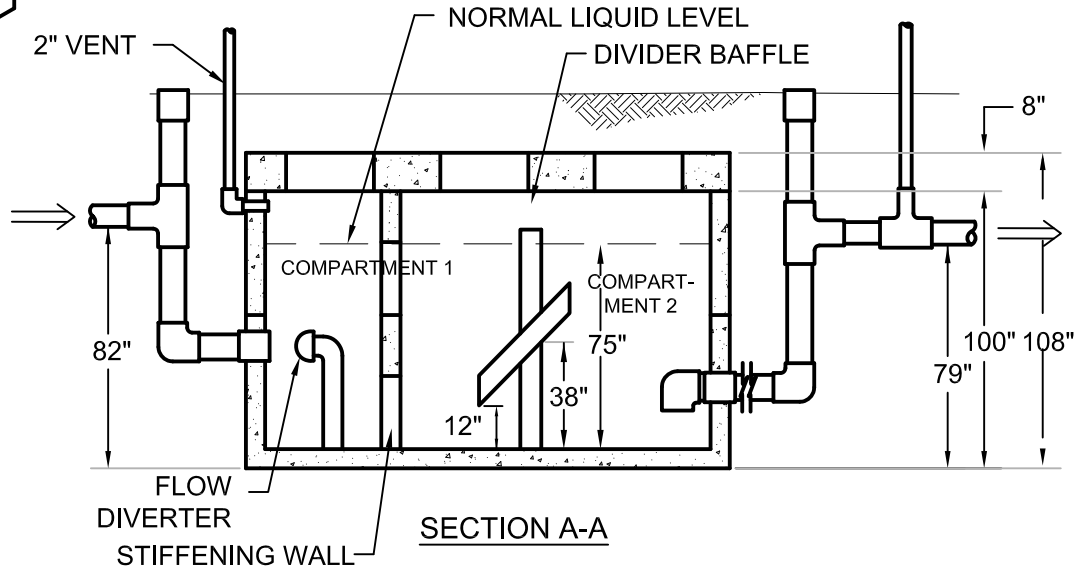
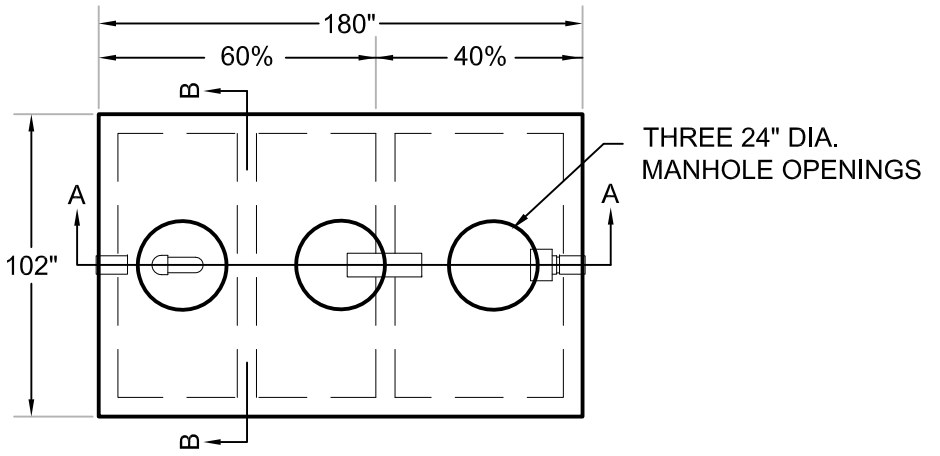

SECTION B-B

STIFFENING WALL
(IN BASE & EXTENSION SECTIONS)

OPENING FOR FLOW THROUGH

"SAN ANTONIO" 5000 GALLON GREASE INTERCEPTOR



HILL COUNTRY
CONCRETE PRODUCTS, INC.

PO Box 357
 Kyle, Texas 78640
 512.268.9711
 Austin Line 512.476.5838
 Fax 512.268.0215
 hillcountryconcrete.com

"SAN ANTONIO" 5000 GALLON GREASE INTERCEPTOR