

RECESSED LIFT HOOKS

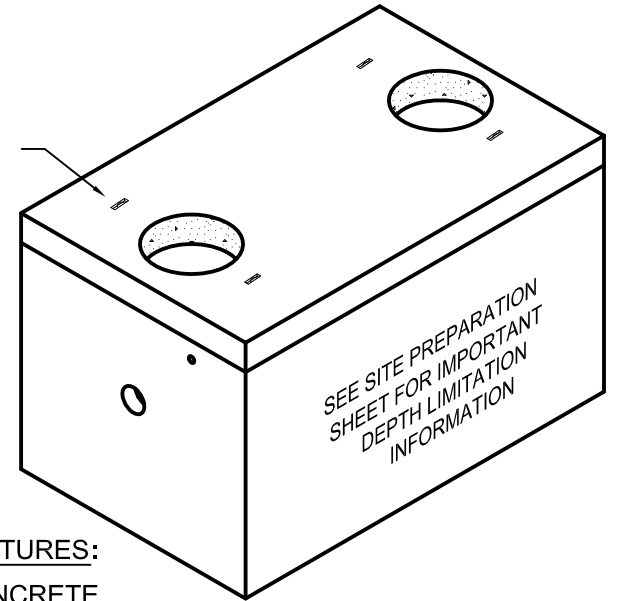

STANDARD FEATURES:

- 4500 PSI CONCRETE
- GRADE 60 REINFORCING
- 8" TRAFFIC BEARING LID
- AASHTO H-20 RATED
- 4" WALLS AND FLOOR

WEIGHT (APPROXIMATE):

TANK	17,000 LBS
8" LID	11,000 LBS

NOTES:

- ALLOW FOR MANHOLE RING AND COVER IN TOTAL HEIGHT
- STANDARD INLET/OUTLET FITTINGS ARE 6" SCH 40 PVC (4" AVAILABLE)
- **MAXIMUM BURY DEPTH TO BOTTOM OF TANK: 9 FT**

3000 GALLON GREASE INTERCEPTOR



HILL COUNTRY
CONCRETE PRODUCTS, INC.

PO Box 357
Kyle, Texas 78640
512.268.9711
Austin Line 512.476.5838
Fax 512.268.0215
hillcountryconcrete.com